

SANYO

INSTRUCTION MANUAL

MOV-112S
MOV-212S

Sterilizer



MOV-212S

Note:

- 1. No part of this manual may be reproduced in any form without the expressed written permission of SANYO.**
- 2. The contents of this manual are subject to change without notice.**
- 3. Please contact SANYO if any point in this manual is unclear or if there are any inaccuracies.**

SANYO Electric Biomedical Co., Ltd. All rights reserved. Printed in Japan.

CONTENTS

PRECAUTIONS FOR SAFE OPERATION	P. 2
CAUTIONS FOR USAGE	P. 6
ENVIRONMENTAL CONDITIONS	P. 6
STERILIZER COMPONENTS	P. 7
INSTALLATION	P. 10
BEFORE COMMENCING OPERATION	P. 11
OPERATING INSTRUCTIONS	P. 12
ALARM & SAFETY FUNCTIONS	P. 17
ROUTINE MAINTENANCE	P. 18
TROUBLE SHOOTING	P. 19
DISPOSAL OF UNIT	P. 19
SPECIFICATIONS	P. 20
PERFORMANCE	P. 20
SAFETY CHECK SHEET	P. 21

PRECAUTIONS FOR SAFE OPERATION

It is imperative that the user complies with this manual as it contains important safety advice.

Items and procedures are described so that you can use this unit correctly and safely. If the precautions advised are followed, this will prevent possible injury to the user and any other person.

Precautions are illustrated in the following way:



WARNING

Failure to observe WARNING signs could result in a hazard to personnel possibly resulting in serious injury or death.

CAUTION

Failure to observe CAUTION signs could result in injury to personnel and damage to the unit and associated property.

Symbol shows;

-  this symbol means caution.
-  this symbol means an action is prohibited.
-  this symbol means an instruction must be followed.

Be sure to keep this manual in a place accessible to users of this unit.

< Label on the unit >

















This mark is labeled on the cover in which the electrical components of high voltage are enclosed to prevent the electric shock.

The cover should be removed by a qualified engineer or a service personnel only.







PRECAUTIONS FOR SAFE OPERATION

WARNING

-  **Do not use the unit outdoors.** Current leakage or electric shock may result if the unit is exposed to rain water.
-  **Only qualified engineers or service personnel should install the unit.** The installation by unqualified personnel may cause electric shock or fire.
-  **Install the unit on a sturdy floor.** If the floor is not strong enough or the installation site is not adequate, this may result in injury from the unit falling or tipping over.
-  **Never install the unit in a humid place or a place where it is likely to be splashed by water.** Deterioration of the insulation may result which could cause current leakage or electric shock.
-  **Never install the unit under the water main or vapor pipe.** Deterioration of the insulation may result which could cause current leakage or electric shock.
-  **Never install the unit in a flammable or volatile location.** This may cause explosion or fire.
-  **Never install the unit where acid or corrosive gases are present** as current leakage or electric shock may result due to corrosion.
-  **Use a dedicated power source** as indicated on the rating label attached to the unit.
-  **Remove dust from the power supply plug** before inserting in a power source. A dusty plug or improper insertion may pose a hazard.
-  **Use a power supply outlet with ground (earth)** to prevent electric shock. If the power supply outlet is not grounded (earthed), it will be necessary to install a ground by qualified engineers.
-  **Never ground the unit through a gas pipe, water main, telephone line or lightning rod.** Such grounding may cause electric shock in the case of an incomplete circuit.
-  **Do not insert metal objects such as a pin or a wire into any vent, gap or any outlet** for inner air circulation. This may cause electric shock or injury by accidental contact with moving parts.
-  **Never store volatile or flammable substances** in this unit. This may cause explosion or fire.
-  **Use this unit in a safe area if using poisonous, harmful or radioactive substances.** Improper use may be harmful to your health or the environment.
-  **Disconnect the power supply to the unit prior to any repair or maintenance** in order to prevent electric shock or injury.

















PRECAUTIONS FOR SAFE OPERATION

WARNING

-  **Ensure you do not inhale or consume medication or aerosols** from around the unit at the time of maintenance. These may be harmful to your health.
-  **Never splash water directly onto the unit** as this may cause electric shock or short circuit.
-  **Never disassemble, repair, or modify the unit yourself.** Any such work carried out by an unauthorized person may result in fire or injury due to a malfunction.
-  **Disconnect the power supply plug if there is anything wrong with the unit.** Continued abnormal operation may cause electric shock or fire.
-  If the unit is to be stored unused in an unsupervised area for an extended period, **ensure that children do not have access and that doors cannot be closed completely.**
-  **The disposal of the unit should be undertaken by appropriate personnel. Remove doors** to prevent accidents such as suffocation.
-  **Prepare a safety check sheet** when you request any repair or maintenance for the safety of service personnel.

PRECAUTIONS FOR SAFE OPERATION

CAUTION

-  **Select a level and sturdy floor for installation.** This precaution will prevent the unit from tipping. Improper installation may result in water spillage or injury from the unit tipping over.
-  **Connect the unit to a power source as indicated on the rating label attached to the unit.** Use of any other voltage or frequency other than that on the rating label may cause fire or electric shock.
-  **Fix the shelves securely.** Incomplete installation may cause injury or damage.
-  **When removing the plug from the power supply outlet, grip the power supply plug, not the cord.** Pulling the cord may result in electric shock or fire by short circuit.
-  **Never damage or break the power supply plug or cord. Do not use the supply plug if its cord is loose.** This may cause fire or electric shock.
-  **Do not touch any electrical parts** such as the power supply plug or any switches with a wet hand. This may cause electric shock.
-  **Check the setting when resuming the operation after power failure or switch off.** The stocked materials may be affected if the setting is changed.
-  **Do not put a container with water or heavy articles on the unit.** It may cause injury if the articles fall. Current leakage or electric shock may result from deterioration of insulation by spilled water.
-  **Do not climb onto the unit and do not put articles on the unit.** This may cause injury by tipping or damage to the unit.
-  **Never touch the inside chamber, door glass, exhaust vent or inside of the door** when the unit is operating with high temperature setting as it may cause burn.
-  **Hold the handle when closing the door.** This will reduce the likelihood of a trapped finger.
-  **Never place your hand on the glass or use excessive force on the glass.** Intentional force may break the glass resulting in injury from the broken glass.
-  **Do not lean on the door.** This may cause injury, current leakage, or electric shock if the unit tips over or door becomes detached.
-  **Disconnect the power supply plug** before moving the unit. Take care not to damage the power cord. A damaged cord may cause electric shock or fire.
-  **Be careful not to tip over the unit** during movement to prevent damage or injury.
-  **Disconnect the power plug** when the unit is not used for long periods.
-  **Do not put the packing plastic bag within reach of children** as suffocation may result.

CAUTIONS FOR USAGE

1. This unit is not explode-proof construction. Never store the materials which cause flammable or volatile gas and never store the flammable or volatile liquid in the unit.
2. The door glass, inside door panel, and exhaust vent are very hot when the unit is used with high temperature setting. Never touch such portion directly with the hands.
3. Avoid to open the door when the chamber temperature is more than 100°C as it is dangerous. The door opening may cause ignition of flammable material or break of equipment resulting from sudden temperature change.
4. Do not block the air intake vent on the chamber floor by the stocked articles. The blockage can cause unstable chamber temperature and shorten the heater life.
5. When cleaning, do not use brushes, acids, benzine, thinner, soap, cleaner or hot water. These will cause discoloring or damage to coated surfaces. On plastic or rubber parts, they will cause transformation, discoloration or degeneration. Never apply volatile chemicals (like benzine etc.) on plastic or rubber parts. When neutral detergent is used, be sure to wipe it up thoroughly with a wet cloth afterwards. Before cleaning the box, refer to page 18.
6. When placing objects inside, remove traces of water as much as possible.
7. When stacking the unit, always use stacking kit available as an optional component.

ENVIRONMENTAL CONDITIONS

This equipment is designed to be safe under the following conditions (based on the IEC 1010-1):

1. Indoor use;
2. Altitude up to 2000 m;
3. Ambient temperature 5°C to 35°C
4. Maximum relative humidity 80% for temperature up to 31°C decreasing linearly to 50% relative humidity at 40°C;
5. Mains supply voltage fluctuations not to exceed $\pm 10\%$ of the nominal voltage;
6. Other supply voltage fluctuations as stated by the manufacturer;
7. Transient overvoltages according to Installation Categories (Overvoltage Categories) II; For mains supply the minimum and normal category is II;
8. Pollution degree 2 in accordance with IEC 664.

STERILIZER COMPONENTS

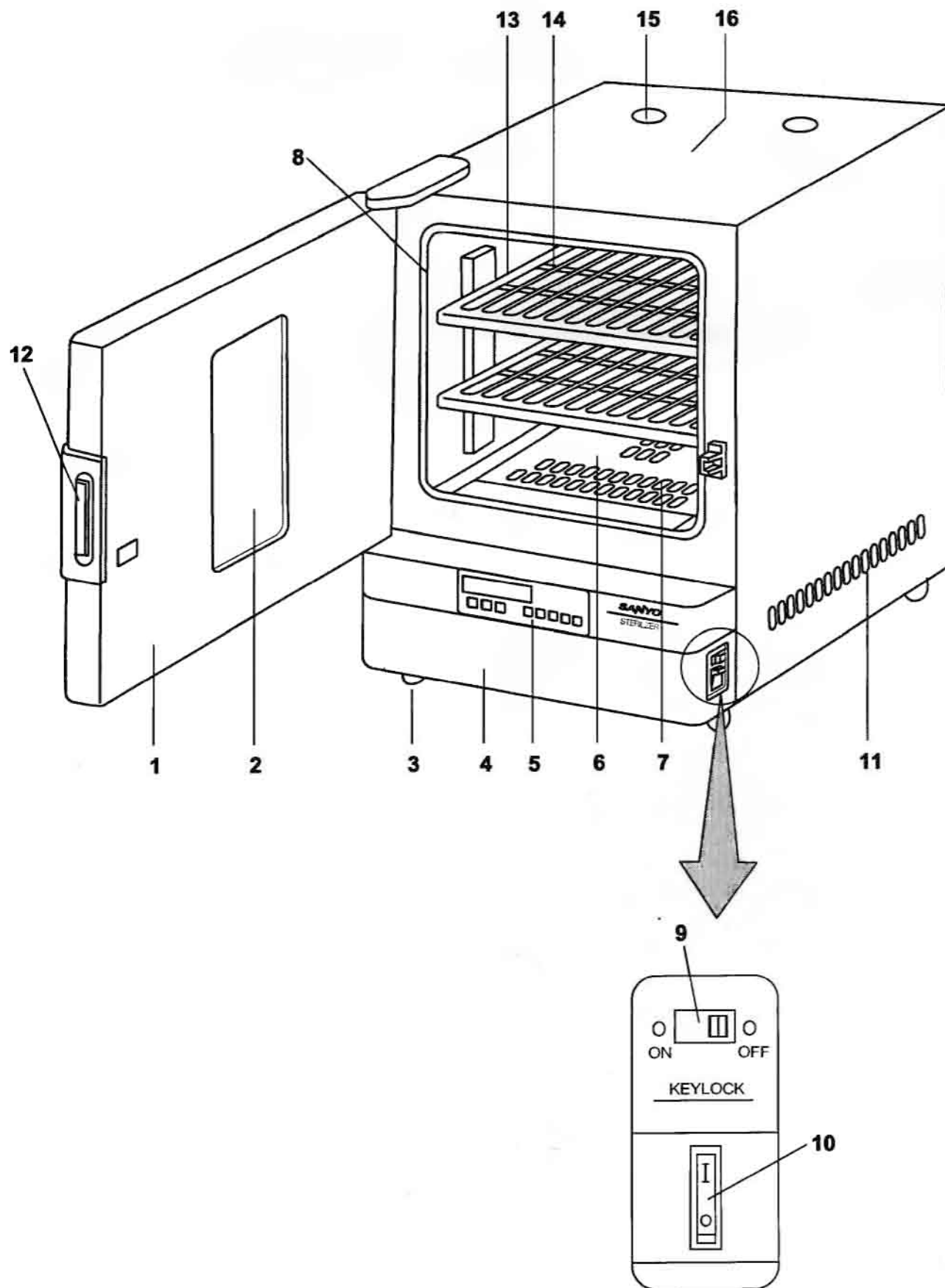

STERILIZER COMPONENTS

- 1. Door:** During use, inner panel of the door becomes extremely hot; Be careful.
- 2. Observation window:** During use, glass and its surrounding become very hot; Be careful.
- 3. Leveling foot:** Made of rubber. Can be adjusted by screws.
- 4. Fan (inside):** Propeller type. To cool down the heat discharge plate and fan motor.
- 5. Control panel:** Refer to page 9.
- 6. Separation plate:** Do not place objects directly on the plate. Especially if the holes are covered, the proper temperature cannot be obtained.
- 7. Heater box (inside):** The heater is attached under separation plate. The sirocco fan is also attached in this box.
- 8. Packing:** Be careful not to scratch.
- 9. Key lock switch:** Put the switch to "OFF" when you set the operating condition. After the setting, put the switch to "ON" to prevent the set condition from changing by accidental contact.
- 10. Main power switch with circuit breaker:** Main switch for all power. When the operation of the unit is stopped by this circuit breaker, contact with a dealer or a service station after disconnected the power supply plug.
- 11. Exhaust air vents:** The air inside the oven is exhausted from these vents. Be careful not to block these vents.
- 12. Handle:** Pull the knob of inside of the handle to open the door.
- 13. Rack support:** This can be adjusted to change the height.
- 14. Rack:** They can be slid forward.
- 15. Exhaust air vent:** The exhaust is controlled by opening/closing the vent. During use, the temperature of this section is extremely high; Be careful.
- 16. Temperature sensor (installation position):** Be careful not to allow objects to touch the sensor or scratch it.

STERILIZER COMPONENTS

Control panel and keypad

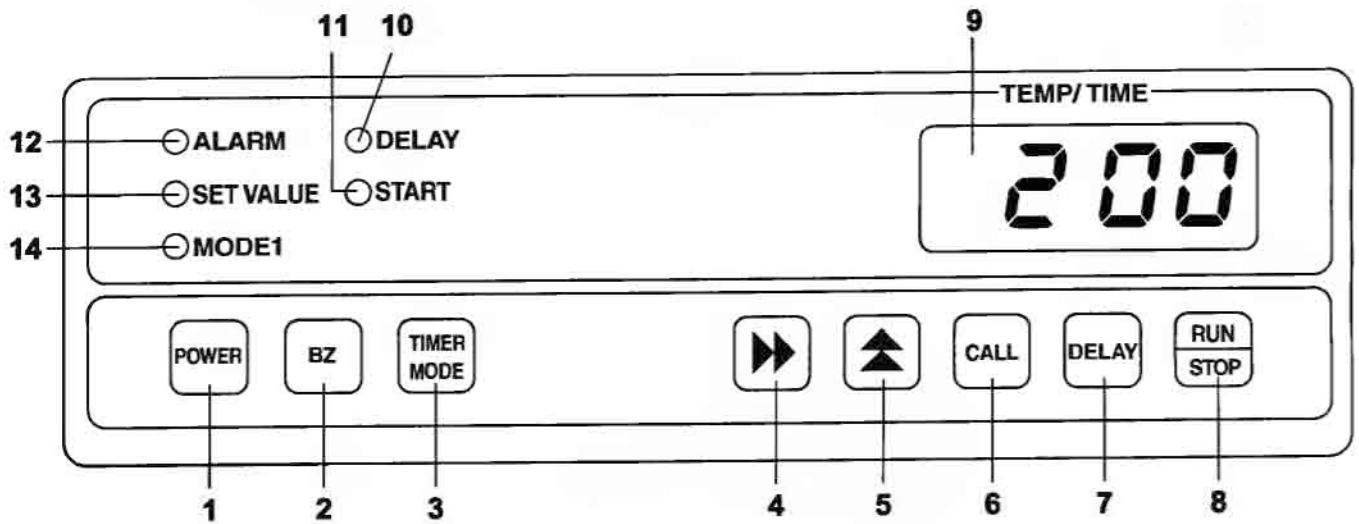

- 1. Power switch (POWER):** Power switch of the control panel.
- 2. Alarm buzzer stop key (BZ):** Press this key to silence the buzzer in the event that the alarm operates and the buzzer sounds. Press it once again to reactive the buzzer.
- 3. Timer mode select key (TIMER MODE):** By pressing this key, the timer mode is selected. Refer to the "Timer function" on page 13.
- 4. Digit shift key (▶▶):** Pressing this key in the setting mode causes the changeable digit to shift.
- 5. Numerical value shift key (▲):** Pressing this key in the setting mode causes the numerical value to shift.
- 6. Call key (CALL):** By pressing this key, the unit enters the setting mode, and the digits that can be set flash, except that only set value display mode is available when unit is running.
- 7. Delay timer key (DELAY):** Pressing this key results in delayed starting of running.
- 8. Run/Stop key (RUN/STOP):** This key is for start/stop the running.
- 9. Digital temperature/timer indicator (TEMP/TIME):** This indicator shows the temperature or the time.
- 10. Delay timer lamp:** This lamp lights when the delay timer is active.
- 11. Start lamp:** This lamp lights when the unit is running.
- 12. Alarm lamp:** This lamp lights when the unit is warning condition.
- 13. Set value lamp:** This lamp lights when setting mode or set value display mode as the unit is running.
- 14. Timer mode 1 lamp:** This lamp lights when timer mode 1 is active.

INSTALLATION

Installation site

To operate this unit properly and to obtain maximum performance, install the unit in a location with the following conditions:

1. A location not subjected to direct sunlight or direct air flow from an air conditioner

2. A location with adequate ventilation

Leave at least 30 cm around the unit for ventilation. Poor ventilation will result in a reduction of the performance.

3. A location away from heat generating sources

Avoid installing the unit near heat-emitting appliances such as gas ranges or stoves.

4. A location with a sturdy and level floor

WARNING

Install the unit on a sturdy floor. If the floor is not strong enough or the installation site is not adequate, this may result in injury from the unit falling or tipping over.

Select a level and sturdy floor for installation. This precaution will prevent the unit from tipping. Improper installation may result in water spillage or injury from the unit tipping over.

5. A location without flammable or corrosive gas

WARNING

Never install the unit in a flammable or volatile location. This may cause explosion or fire.

Never install the unit where acid or corrosive gases are present as current leakage or electric shock may result due to corrosion.

6. A location not prone to high humidity

WARNING

Do not use the unit outdoors. Current leakage or electric shock may result if the unit is exposed to rain water.

Never install the unit in a humid place or a place where it is likely to be splashed by water. Deterioration of the insulation may result which could cause current leakage or electric shock.

INSTALLATION

Installation

1. Remove the packaging materials and tapes

Remove all transportation packaging materials and tapes. Open the doors and ventilate the unit. If the outside panels are dirty, clean them with a neutral detergent and wipe it up with a wet cloth.

2. Adjust the leveling feet

Extend the leveling legs by rotating them counterclockwise so they contact the floor or bench. Ensure the unit is level.

3. Ground (earth)

WARNING

Use a power supply outlet with ground (earth) to prevent electric shock. If the power supply outlet is not grounded, it is necessary to install a ground by qualified engineers.

Never ground the unit through a gas pipe, water main, telephone line or lightning rod. Such grounding may cause electric shock in the case of an incomplete circuit.

BEFORE COMMENCING OPERATION

Prerunning

When using the unit for the first time after purchasing, operate the unit without objects inside.

1. Install the racks in the chamber.
2. Set the temperature at 200°C and operate the unit for 20 minutes.
3. Leave the unit as it is until the chamber temperature is cool enough.
4. Ventilate the room when opening the chamber door as the smoke with a strong odor is exhausted.
5. Keep the chamber door opened for a while until the odor is eliminated.

Note:

Some odor may be remained after prerunning. Such residue is eliminated gradually during usage.

OPERATING INSTRUCTIONS

Basic operating flow chart of control panel

1. Start of operation when the input of setting is conducted.

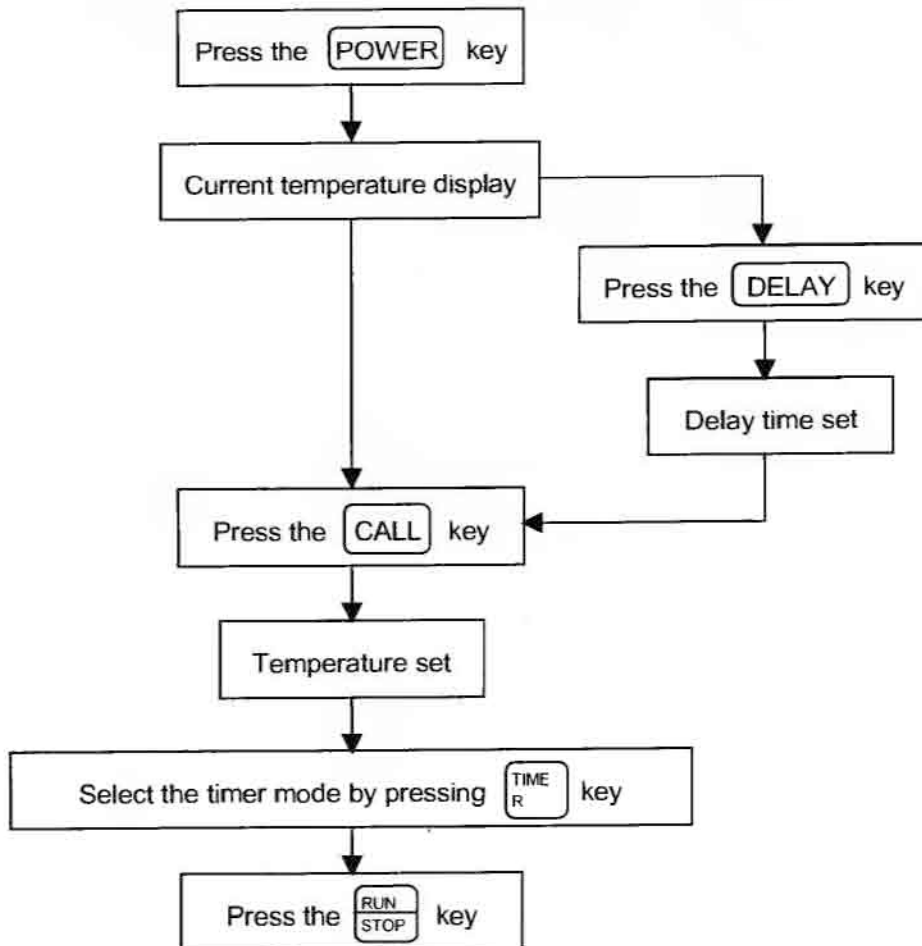

2. Start of operation with no change of setting

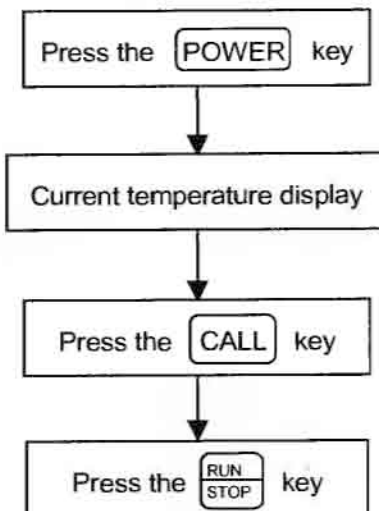

OPERATING INSTRUCTIONS

Timer function

The timer function has two modes as follows:

1. Normal mode: starts immediately after start of the running
2. Timer mode 1: starts when the chamber temperature is 2.0°C lower than the set point.

When conducting the sterilization, always select "Timer mode 1".

On timer mode 1, the timer starts when the chamber temperature is 2.0°C lower than the set point. After timer starting, the temperature indicator blinks, alarm lamp lights, and intermittent tone sounds if the chamber temperature is 5.0°C or more lower than set point due to the door opening, etc.

In spite of the alarm condition, the unit continues to run. The timer is reset to initial setting when the chamber temperature is 2.0°C lower than the set point again.

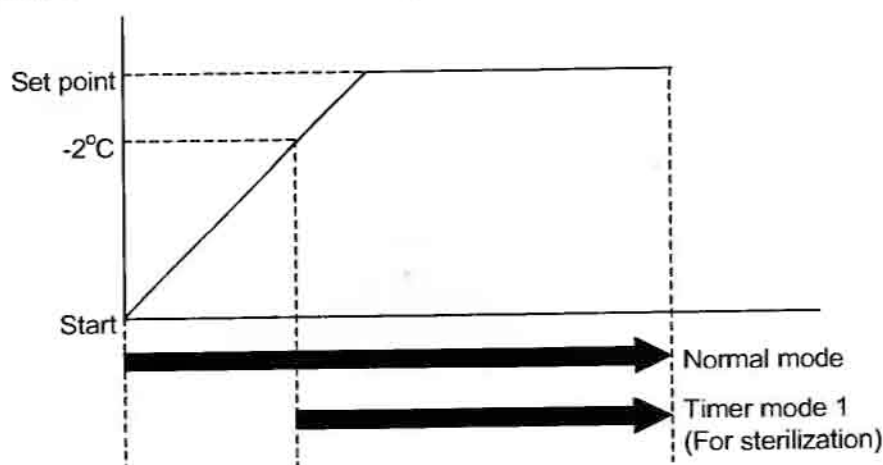

Sterilization

- Refer to the table below when setting the sterilization temperature and duration.

Sterilization temperature	Sterilization duration
135 to 145°C	3 to 5 hours
160 to 170°C	2 to 4 hours
180 to 200°C	0.5 to 1 hour

In case of sterilizing a lot of samples, extend the sterilization time for more than an hour.

- When sterilizing the combustibles, such as cotton capped tube and instrument which are covered with paper, do not put them on the shelves directly. Use the wire basket and upper shelves instead.
- When sterilizing the pipettes or the glass pipes, waterdrop must be dried out clearly, otherwise sterilization will not be completed.
- Take out the articles in the chamber when the chamber temperature is lower than 50°C.

Note:

Do not open the door during sterilization.

Do not open the door when the chamber temperature is higher than 100°C.

OPERATING INSTRUCTIONS

Stable running

Table below shows the basic procedure for setting the chamber temperature. Perform key operations in the sequence indicated in the table. The example in the table is based on the assumption that the desired temperature is 50°C and continuous running.

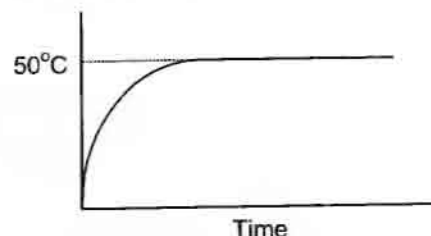

Basic operation sequence (Example: Chamber temperature; 50°C, Continuous running)

	Description of operation	Key operated	Indication after operation
1	Press the power key.		<ul style="list-style-type: none"> <input type="radio"/> ALARM <input type="radio"/> DELAY <input type="radio"/> SET VALUE <input type="radio"/> START <input type="radio"/> MODE 1 <div style="text-align: right; margin-right: 20px;"> </div> <p>(The current chamber temperature is displayed.)</p>
2	(Delay time reset) Press the delay timer key.		<ul style="list-style-type: none"> <input type="radio"/> ALARM <input checked="" type="radio"/> DELAY <input type="radio"/> SET VALUE <input type="radio"/> START <input type="radio"/> MODE 1 <div style="text-align: right; margin-right: 20px;"> </div> <p>(The fourth digit of the indicator flashes.)</p>
3	Press the delay timer key to reset the delay time.		<ul style="list-style-type: none"> <input type="radio"/> ALARM <input checked="" type="radio"/> DELAY <input checked="" type="radio"/> SET VALUE <input type="radio"/> START <input type="radio"/> MODE 1 <div style="text-align: right; margin-right: 20px;"> </div>
4	Press the delay timer key and the current chamber temp. is displayed.		<ul style="list-style-type: none"> <input type="radio"/> ALARM <input type="radio"/> DELAY <input type="radio"/> SET VALUE <input type="radio"/> START <input type="radio"/> MODE 1 <div style="text-align: right; margin-right: 20px;"> </div>
5	(Temperature set) Press the call key.		<ul style="list-style-type: none"> <input type="radio"/> ALARM <input type="radio"/> DELAY <input checked="" type="radio"/> SET VALUE <input type="radio"/> START <input type="radio"/> MODE 1 <div style="text-align: right; margin-right: 20px;"> </div> <p>(The third digit of the indicator flashes.)</p>
6	Set the temp. to 050 with the digit shift key and the numeric value shift key.		<ul style="list-style-type: none"> <input type="radio"/> ALARM <input type="radio"/> DELAY <input checked="" type="radio"/> SET VALUE <input type="radio"/> START <input type="radio"/> MODE 1 <div style="text-align: right; margin-right: 20px;"> </div>
7	(Time set) Press the call key.		<ul style="list-style-type: none"> <input type="radio"/> ALARM <input type="radio"/> DELAY <input checked="" type="radio"/> SET VALUE <input type="radio"/> START <input type="radio"/> MODE 1 <div style="text-align: right; margin-right: 20px;"> </div> <p>(The fourth digit of the indicator flashes.)</p>
8	Set the time to --:-- with the digit shift key and numeric value shift key.		<ul style="list-style-type: none"> <input type="radio"/> ALARM <input type="radio"/> DELAY <input checked="" type="radio"/> SET VALUE <input type="radio"/> START <input type="radio"/> MODE 1 <div style="text-align: right; margin-right: 20px;"> </div>
9	(Start running) Press the run/stop key.		<ul style="list-style-type: none"> <input type="radio"/> ALARM <input type="radio"/> DELAY <input type="radio"/> SET VALUE <input checked="" type="radio"/> START <input type="radio"/> MODE 1 <div style="text-align: right; margin-right: 20px;"> </div> <p>(The unit runs.)</p>

Note:

When the delay time is not set, operation 2, 3, and 4 is not necessary.

--:-- of the indicator is displayed by the numerical value shift key at fourth digit flashing.

OPERATING INSTRUCTIONS

Stable running with delay time

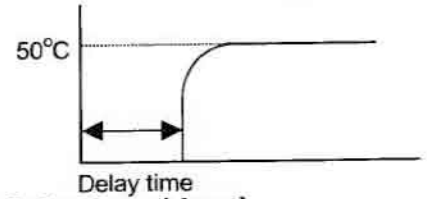

Basic operation sequence (Example: Chamber temperature; 50°C, Delay time; 1 hour)

	Description of operation	Key operated	Indication after operation
1	Press the power key.		<ul style="list-style-type: none"> <input type="radio"/> ALARM <input type="radio"/> SET VALUE <input type="radio"/> MODE 1 <input type="radio"/> DELAY <input type="radio"/> START <p>(The current chamber temperature is displayed.)</p>
2	(Delay time reset) Press the delay timer key.		<ul style="list-style-type: none"> <input type="radio"/> ALARM <input checked="" type="radio"/> SET VALUE <input type="radio"/> MODE 1 <input checked="" type="radio"/> DELAY <input type="radio"/> START <p>(The fourth digit of the indicator flashes.)</p>
3	Set the time to 01:00 with the digit shift key and the numeric value shift key.		<ul style="list-style-type: none"> <input type="radio"/> ALARM <input checked="" type="radio"/> SET VALUE <input type="radio"/> MODE 1 <input checked="" type="radio"/> DELAY <input type="radio"/> START
4	Press the delay timer key and the current chamber temp. is displayed.		<ul style="list-style-type: none"> <input type="radio"/> ALARM <input type="radio"/> SET VALUE <input type="radio"/> MODE 1 <input type="radio"/> DELAY <input type="radio"/> START
5	(Temperature set) Press the call key.		<ul style="list-style-type: none"> <input type="radio"/> ALARM <input checked="" type="radio"/> SET VALUE <input type="radio"/> MODE 1 <input type="radio"/> DELAY <input type="radio"/> START <p>(The third digit of the indicator flashes.)</p>
6	Set the temp. to 050 with the digit shift key and the numeric value shift key.		<ul style="list-style-type: none"> <input type="radio"/> ALARM <input checked="" type="radio"/> SET VALUE <input type="radio"/> MODE 1 <input type="radio"/> DELAY <input type="radio"/> START
7	(Time set) Press the call key.		<ul style="list-style-type: none"> <input type="radio"/> ALARM <input checked="" type="radio"/> SET VALUE <input type="radio"/> MODE 1 <input type="radio"/> DELAY <input type="radio"/> START <p>(The fourth digit of the indicator flashes.)</p>
8	Set the time to --:-- with the digit shift key and numeric value shift key.		<ul style="list-style-type: none"> <input type="radio"/> ALARM <input checked="" type="radio"/> SET VALUE <input type="radio"/> MODE 1 <input type="radio"/> DELAY <input type="radio"/> START
9	(Start running) Press the run/stop key.		<ul style="list-style-type: none"> <input type="radio"/> ALARM <input type="radio"/> SET VALUE <input type="radio"/> MODE 1 <input checked="" type="radio"/> DELAY <input checked="" type="radio"/> START <p>(The unit runs.)</p>

Start of operation with no change of setting

	Description of operation	Key operated	Indication after operation
1	Press the power key.		<ul style="list-style-type: none"> <input type="radio"/> ALARM <input type="radio"/> SET VALUE <input type="radio"/> MODE 1 <input type="radio"/> DELAY <input type="radio"/> START <p>(The current chamber temp. is displayed.)</p>
2	Press the call key		<ul style="list-style-type: none"> <input type="radio"/> ALARM <input checked="" type="radio"/> SET VALUE <input type="radio"/> MODE 1 <input type="radio"/> DELAY <input type="radio"/> START <p>(The third digit of the indicator flashes.)</p>
3	Press the run/stop key.		<ul style="list-style-type: none"> <input type="radio"/> ALARM <input type="radio"/> SET VALUE <input type="radio"/> MODE 1 <input type="radio"/> DELAY <input checked="" type="radio"/> START <p>(The unit runs.)</p>

OPERATING INSTRUCTIONS

Sterilization with timer mode 1

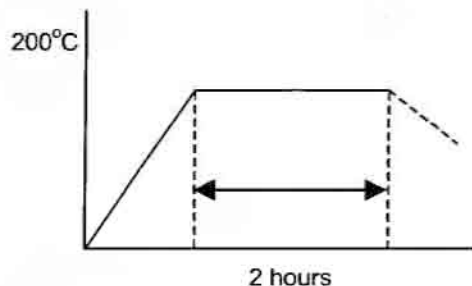

Basic operation sequence (Example: Chamber temperature; 180°C, Delay time; 2 hours)

	Description of operation	Key operated	Indication after operation
1	Press the power key.		<ul style="list-style-type: none"> <input type="radio"/> ALARM <input type="radio"/> SET VALUE <input type="radio"/> MODE 1 <input type="radio"/> DELAY <input type="radio"/> START <p>(The current chamber temperature is displayed.)</p>
2	(Release of delay set time) Press the delay timer key.		<ul style="list-style-type: none"> <input type="radio"/> ALARM <input type="radio"/> SET VALUE <input type="radio"/> MODE 1 <input checked="" type="radio"/> DELAY <input type="radio"/> START <p>(The fourth digit of the indicator flashes.)</p>
3	Press the delay timer key to reset the delay time.		<ul style="list-style-type: none"> <input type="radio"/> ALARM <input checked="" type="radio"/> SET VALUE <input type="radio"/> MODE 1 <input checked="" type="radio"/> DELAY <input type="radio"/> START
4	Press the delay timer key and the current chamber temp. is displayed.		<ul style="list-style-type: none"> <input type="radio"/> ALARM <input type="radio"/> SET VALUE <input type="radio"/> MODE 1 <input type="radio"/> DELAY <input type="radio"/> START
5	(Temperature set) Press the call key.		<ul style="list-style-type: none"> <input type="radio"/> ALARM <input checked="" type="radio"/> SET VALUE <input type="radio"/> MODE 1 <input type="radio"/> DELAY <input type="radio"/> START <p>(The third digit of the indicator flashes.)</p>
6	Set the temp. to 180 with the digit shift key and the numeric value shift key.		<ul style="list-style-type: none"> <input type="radio"/> ALARM <input checked="" type="radio"/> SET VALUE <input type="radio"/> MODE 1 <input type="radio"/> DELAY <input type="radio"/> START
7	(Time set) Press the call key.		<ul style="list-style-type: none"> <input type="radio"/> ALARM <input checked="" type="radio"/> SET VALUE <input type="radio"/> MODE 1 <input type="radio"/> DELAY <input type="radio"/> START <p>(The fourth digit of the indicator flashes.)</p>
8	Set the time to 02:00 with the digit shift key and numeric value shift key.		<ul style="list-style-type: none"> <input type="radio"/> ALARM <input checked="" type="radio"/> SET VALUE <input checked="" type="radio"/> MODE 1 <input type="radio"/> DELAY <input type="radio"/> START
9	(Timer mode 1 set) Press the timer mode select key.		<p>(The timer mode 1 lamp is lighted.)</p>
10	(Start of operation) Press the run/stop key.		<ul style="list-style-type: none"> <input type="radio"/> ALARM <input type="radio"/> SET VALUE <input checked="" type="radio"/> MODE 1 <input type="radio"/> DELAY <input checked="" type="radio"/> START <p>(The unit runs.)</p>

ALARMS & SAFETY FUNCTIONS

This unit has the alarms and safety functions shown in table below, and also self diagnostic functions.

Alarms and safety functions

Alarm & Safety	Situation	Indication	Buzzer	Safety operation
Automatic set temperature Alarm	If the internal temperature deviates from the set temperature by +10°C or more (and if timer mode 1, by -5°C or more)	Alarm lamp lights. All digits on the indicator flash.	Intermittent tone	----
Auto return	If a key operation is not performed for about 45 sec. in each setting mode.	Normal display mode.	----	The setting mode is cancelled.
Key lock switch	When the key lock switch is turned ON.	----	----	Key input is disabled.
Temperature sensor abnormality	If the temperature sensor goes open circuit.	Alarm lamp lights. E01 is displayed on the indicator.	Intermittent tone	Heater OFF
Triac abnormality	If the triac goes open circuit.	Alarm lamp lights. E02 is displayed on the indicator.	Intermittent tone	Heater OFF
	If the triac goes short circuit.	Alarm lamp lights. E03 is displayed on the indicator.	Intermittent tone	Heater OFF
Relay abnormality	If the relay goes short circuit.	Alarm lamp lights. E04 is displayed on the indicator.	Intermittent tone	Heater OFF
	If the relay goes open circuit or fan motor and heater goes short circuit. Or the ambient temp. of circuit is 65°C or more.	Alarm lamp lights. E05 is displayed on the indicator.	Intermittent tone	Heater OFF
Independent over-heat protection	(when unit is not running) The security circuit is activated by independent temp. sensor if the chamber is abnormal over-heating.	Without display change.	Continuous tone	Heater OFF forcedly by external circuit.
	(When unit is running) The security circuit is activated by independent temp. sensor if the chamber is abnormal over-heating.	Alarm lamp lights. E05 is displayed on the indicator.	Continuous tone (When the temp. is decreased, intermittent tone)	Heater OFF forcedly by external circuit.

* The buzzer tone resulting from the independent over-heat protection cannot be stopped with the BUZZER key. Turn off the main switch.

ROUTINE MAINTENANCE

WARNING

Always disconnect the power supply to the unit prior to any repair or maintenance of the unit in order to prevent electric shock or injury.

Ensure you do not inhale or consume medication or aerosols from around the unit at the time of maintenance. These may be harmful to your health.

CAUTION

Always put on dry gloves to protect hands at the time of maintenance. Failure to use gloves may result in cuts or abrasions from any sharp edges or corners.

Note:

Never attempt to directly spray water on the heater box or the inside of the oven as it is very dangerous. In addition, never use volatile or combustible chemicals to clean the inside.

Cleaning of unit

Cleaning the inside

- Remove all racks from the inside.
- Clean the inside using a soft cloth dampened with neutral detergent. Afterwards, wipe off with a cloth washed in clean water.
- Remove the separation plate at the bottom of the oven and wipe off any particles in the heater box, using a soft cloth dampened with water.

Cleaning the frame

- Clean the frame using a soft cloth dampened with neutral detergent. Afterwards, wipe it up the detergent with a wet cloth.

Cleaning the rack

- To clean the rack, place it in a tub of warm water mixed with neutral detergent and wipe with a sponge or a soft cloth. Racks subject to high temperature will naturally become colored. This is a natural coloration, acknowledge this.

TROUBLE SHOOTING

If the unit malfunctions, check out the following before calling for service.

The unit does not operate at all

1. The unit is not plugged correctly into a power outlet.
2. The circuit breaker at the power source is active.
3. A power failure has occurred.
4. A fuse has blown.

The key operation is disabled

1. The key lock function is set in OFF mode.

If the alarm function operates

If the alarm function and the buzzer operates, check the cause using the following procedure.

[At the beginning of operation]

1. The chamber temperature is not equal to the set value.

[During operation]

1. The set temperature value was changed.
2. The door was left open for a long period.
3. A low temperature load was placed inside the unit.

In these case, if the unit is left as it is, the alarm will eventually clear itself.

If the chamber temperature is not equal to the set temperature

1. The temperature in the vicinity is too high.

The ambient temperature must always be at least 5°C less than the set temperature.

2. The unit is installed tilted.

DISPOSAL OF UNIT

WARNING

If the unit is to be stored unused in an unsupervised area for an extended period **ensure that children do not have access and doors cannot be closed completely.**

The disposal of the unit should be undertaken by appropriate personnel. Always remove doors to prevent accidents such as suffocation.

SPECIFICATIONS

Name	Sterilizer	
Model	MOV-112S	MOV-212S
External dimensions	W580 x D595 x H820 (mm)	W730 x D645 x H870 (mm)
Internal dimensions	W450 x D450x H450 (mm)	W600 x D500x H500 (mm)
Effective capacity	90 L	150 L
Exterior	Electrically galvanized steel plate, Acrylic resin painted	
Interior	Stainless steel plate (SUS 304)	
Door	Electrically galvanized steel plate, Acrylic resin painted	
Observation window	Reinforced glass x 3, W150 x H380 mm	
Insulation	Glass wool	
Rack	Stainless steel plate, Stainless wire (SUS 304)	
Temperature controller	Sensor K, PID control	
Temperature display	Digital display	
Timer	Electronic timer with delay timer	
Circuit breaker	15 A	
Overheat prevention mechanism	Built-in thermister (electric circuit), Thermal guard	
Heater	1.1 kW	1.2 kW
Fan motor	Output 10 W	
Accessories	2 racks, 4 rack supports	3 racks, 6 rack supports
Weight	50 kg	66 kg

Note: Design or specifications will be subject to change without notice.

PERFORMANCE

Model	MOV-112S	MOV-212S
Usable environment condition	Temperature: 0°C to 35°C	
Extent chamber temperature	Ambient temperature +5°C to 200°C	
Temperature control range	± 4°C	
Time of reaching maximum Temperature (0°C → 200°C)	60 minutes	70 minutes
Power source, Rated power consumption	AC110V 60Hz, 1030W AC115 to 120V 60Hz, 1130W AC220 50/60Hz, 1130W AC230 to 240V 50Hz, 1130W	AC110 to 120V 60Hz, 1230W AC220V 50/60Hz, 1230W AC230 to 240V 50Hz, 1230W

Note: The unit with CE mark complies with EC directives 89/336/EEC, 93/68/EEC and 73/23/EEC.

CAUTION

Please fill in this form before servicing.
Hand over this form to the service engineer to keep for his and your safety.

Safety check sheet

1. Refrigerator contents : Yes No
Risk of infection: Yes No
Risk of toxicity: Yes No
Risk from radioactive sources: Yes No

(List all potentially hazardous materials that have been stored in this unit.)

Notes :

2. Contamination of the unit
- Unit interior Yes No
No contamination Yes No
Decontaminated Yes No
Contaminated Yes No
Others:

3. Instructions for safe repair/maintenance of the unit
- a) The unit is safe to work on Yes No
b) There is some danger (see below) Yes No
Procedure to be adhered to in order to reduce safety risk indicated in b) below.

Date :

Signature :

Address, Division :

Telephone :

Product name : Sterilizer	Model : MOV-112S, MOV-212S	Serial number :	Date of Installation :
------------------------------	-------------------------------	-----------------	------------------------

Please decontaminate the unit yourself before calling the service engineer.